

PIUSI

*Fluid Handling
Innovation*

K600
ELECTRONIC
METER



**MADE
IN
ITALY**

Use, maintenance and calibration manual

EN

BULLETIN MO147E EN_00

ENGLISH

1 INDEX

| | | |
|----|--|----|
| 1 | FACSIMILE COPY OF EU DECLARATION OF CONFORMITY | 3 |
| 2 | GENERAL WARNINGS | 3 |
| 3 | SAFETY INSTRUCTIONS | 4 |
| | 3.1 SAFETY WARNINGS | 4 |
| | 3.2 FIRST AID RULES | 4 |
| | 3.3 GENERAL SAFETY RULES | 4 |
| | 3.4 PACKAGING | 5 |
| | 3.5 PACKAGE CONTENTS/PRE-INSPECTION | 5 |
| 4 | KNOWLEDGE K600 | 5 |
| | 4.1 LCD DISPLAY (ONLY METER VERSION) | 6 |
| | 4.2 VERSION PULSER | 7 |
| | 4.3 USERS BUTTONS | 7 |
| 5 | INSTALLATION | 8 |
| 6 | DAILY USE | 8 |
| | 6.1 DISPENSING IN NORMAL MODE | 9 |
| | 6.1.1 PARTIAL RESET (NORMAL MODE) | 9 |
| | 6.1.2 RESETTING THE RESET TOTAL | 10 |
| | 6.2 DISPENSING IN FLOW RATE MODE | 10 |
| | 6.2.1 PARTIAL RESET | 11 |
| 7 | CALIBRATION | 11 |
| | 7.1 DEFINITIONS | 11 |
| | 7.2 CALIBRATION MODE | 11 |
| | 7.2.1 DISPLAY OF CURRENT CALIBRATION FACTOR AND RESTORING FACTORY FACTOR. | 12 |
| | 7.2.2 IN FIELD CALIBRATION | 13 |
| | 7.2.2.1 IN-FIELD CALIBRATION PROCEDURE | 13 |
| | 7.2.3 DIRECT MODIFICATION OF K FACTOR | 14 |
| 8 | METER CONFIGURATION | 15 |
| 9 | MAINTENANCE | 16 |
| | 9.1 CHANGE BATTERY | 16 |
| | 9.2 CLEANING | 17 |
| 10 | MALFUNCTIONS | 18 |
| 11 | DEMOLITION AND DISPOSAL | 18 |
| 12 | TECHNICAL SPECIFICATIONS | 19 |
| 13 | EXPLODED VIEW / DIMENSIONS | 20 |

BULLETIN MO147E

1 FACSIMILE COPY OF EU DECLARATION OF CONFORMITY

The undersigned: PIUSI S.p.A.

Via Pacinotti 16/A z.i. Rangavino - 46029 Suzzara - Mantova - Italy

HEREBY STATES under its own responsibility that the equipment described below:

Description : **METER**

Model: **K600 METER - K600 PULSER**

Serial number: refer to Lot Number shown on CE plate affixed to product

Year of manufacture: refer to the year of production shown on the CE plate affixed to the product
complies with the following legislation:

- Electromagnetic compatibility

The technical file is at the disposal of the competent authority following motivated request at PIUSI S.p.A. or following request sent to the e-mail address: doc_tec@piusi.com.

THE ORIGINAL DECLARATION OF CONFORMITY IS PROVIDED SEPARATELY WITH THE PRODUCT

2 GENERAL WARNINGS

Warnings

To ensure operator safety and to protect the dispensing system from potential damage, workers must be fully acquainted with this instruction manual before attempting to operate the dispensing system.

Symbols used in the manual

The following symbols will be used throughout the manual to highlight safety information and precautions of particular importance:



ATTENTION

This symbol indicates safe working practices for operators and/or potentially exposed persons.



WARNING

This symbol indicates that there is risk of damage to the equipment and/or its components.



NOTE

This symbol indicates useful information.

Manual preservation

This manual should be complete and legible throughout. It should remain available to end users and specialist installation and maintenance technicians for consultation at any time.

Reproduction rights

All reproduction rights are reserved by Piusi S.p.A. The text cannot be reprinted without the written permission of Piusi S.p.A.

© Piusi S.p.A.





THIS MANUAL IS THE PROPERTY OF Piusi S.p.A.

ANY REPRODUCTION, EVEN PARTIAL, IS FORBIDDEN.

This manual belongs to Piusi S.p.A., which is the sole proprietor of all rights indicated by applicable laws, including, by way of example, laws on copyrights. All the rights deriving from such laws are reserved to Piusi S.p.A.: the reproduction, including partial, of this manual, its publication, change, transcription and notification to the public, transmission, including using remote communication media, placing at disposal of the public, distribution, marketing in any form, translation and/or processing, loan and any other activity reserved by the law to Piusi S.p.A..

3 SAFETY INSTRUCTIONS

3.1 SAFETY WARNINGS

| | | |
|---|---|---|
| <p>Mains - preliminary checks before installation</p> |  | <p>ATTENTION You must avoid any contact between the electrical power supply and the fluid that needs to be FILTERED.</p> |
| <p>Maintenance control</p> | | <p>Before any checks or maintenance work are carried out, disconnect the power source.</p> |
| <p>FIRE AND EXPLOSION</p> |  | <p>Connect the metal parts of the device to earth Stop operation immediately if static sparking occurs or if you feel a shock. Do not use equipment until you identify and correct the problem. Keep a working fire extinguisher in the work area.</p> |
| <p>EQUIPMENT MISUSE Misuse can cause death or serious injury</p> |  | <p>Do not operate the unit when fatigued or under the influence of drugs or alcohol. Do not leave the work area while equipment is energized or under pressure. Turn off all equipment when equipment is not in use. Do not alter or modify equipment. Alterations or modifications may void agency approvals and create safety hazards. Route hoses and cables away from traffic areas, sharp edges, moving parts, and hot surfaces. Keep children and animals away from work area. Comply with all applicable safety regulations.</p> |
| <p>TOXIC FLUID OR FUMES HAZARD</p> |  | <p>Read MSDS's to know the specific hazards of the fluids you are using. Store hazardous fluid in approved containers, and dispose of it according to applicable guidelines. Prolonged contact with the treated product may cause skin irritation: always wear protective gloves during dispensing.</p> |

3.2 FIRST AID RULES

| | | |
|----------------------------------|---|---|
| <p>SMOKING PROHIBITED</p> |  | <p>When operating the system and in particular during refuelling, do not smoke and do not use open flame.</p> |
|----------------------------------|---|---|

3.3 GENERAL SAFETY RULES

Essential protective equipment characteristics Wear protective equipment that is: suited to the operations that need to be performed; resistant to cleaning products.

- Personal protective equipment that must be worn**
-  Safety shoes;
 -  Close-fitting clothing;
 -  Protective gloves;
 -  Safety goggles;

Protective equipment Instruction manual

3.4 PACKAGING

FOREWORD

- 1 - contents of the package
- 2 - weight of the contents
- 3 - description of the product

K600 comes packed in a cardboard box with a label indicating the following data:

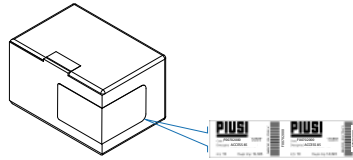

3.5 PACKAGE CONTENTS/PRE-INSPECTION

FOREWORD

To open the packaging, use a pair of scissors or a cutter, being careful not to damage the dispensing system or its components.

NOTE



In the event that one or more of the components described below are missing from inside the package, please contact Piusi inc technical support.

WARNING



Check that the data on the plate correspond to the desired specifications. In the event of any anomaly, contact the supplier immediately, indicating the nature of the defects. Do not use equipment which you suspect might not be safe.

4 KNOWLEDGE K600

FOREWORD

K600 - meter and pulser versions - represents a family of meters developed to satisfy a wide range of requirements for the control, measurement, dispensing and transfer of lubricating oils and fuels.

measurement principle

Its measurement principle is based on elliptical gears that provide high accuracy over a wide range of flow rates together with reduced loss of head. The fluid passing through the instrument turns the gears whose rotation transfers constant "fluid units". The exact measurement of the fluid dispensed is carried out by counting the rotations of the gears and, thus, the "fluid units" transferred. The magnetic coupling, consisting of magnets installed in the gears and a magnetic switch located outside the measuring chamber, guarantees the seal of the measuring chamber and ensures the transmission of the impulses generated by the rotation of the gears to the microprocessor.

The meter housing is manufactured of extruded aluminium and is furnished with external guides for a practical and simple installation. The various models are differentiated by the length of the housing, which is related to their ability to function at higher flow rates.

The meter body is made of die-cast aluminium and fitted with connections for the installation of threaded flanges, suitable for any type of tubing.

At the inlet opening, a filtering disk of stainless steel mesh is installed, which can be accessed from the outside by removing the flange close to the flow inlet side.

operating modes

Normal Mode: Mode with display of Partial and Total dispensed quantities

Flow Rate Mode: Mode with display of Flow Rate, as well as Partial dispensed quantity

The METER features a non-volatile memory for storing the dispensing data, even in the event of a complete power break for long periods.

Main components: K600

- 1 - Display LCD
- 2 - RESET button
- 3 - Measuring chamber
- 4 - CAL button
- 5 - Battery housing
- 6 - Filter

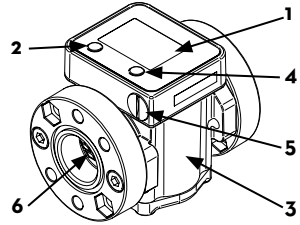

The measurement electronics and the LCD display are fitted in the top part of the meter, isolated from the fluid-bath measuring chamber and sealed from the outside by means of a cover.

COMPATIBLE LIQUIDS

- DIESEL FUEL at a viscosity of from 2 to 5.35 cSt (at a temperature of 37.8°C), Minimum Flash Point (PM): 55°C, according to UNI EN 590
- MOTOR OIL : SYNTHETIC / MINERAL
- PARAFFINIC DIESEL HVO & XTL (GTL/BTL/CTL/PTL) according to the EN 15940:2019

4.1 LCD DISPLAY (ONLY METER VERSION)

FOREWORD The “LCD” of the METER features two numerical registers and various indications displayed to the user only when the applicable function so requires.

| | | | |
|---|---|---|---|
| 1 | Partial register (5 figures with moving comma FROM 0.1 to 99999) indicating the volume dispensed since the reset button was last pressed | 6 | Indication of type of total, (TOTAL / Reset TOTAL); |
| 2 | Indication of battery charge | 7 | Indication of unit of measurement of Totals: L=Litres Gal=Gallons |
| 3 | Indication of calibration mode | 8 | Indication of Flow Rate |
| 4 | Totals register (6 figures with moving comma FROM 0.1 to 999999), that can indicate two types of Total: 4.1. General Total that cannot be reset (TOTAL) 4.2. Resettable total (Reset TOTAL) | 9 | Indication of unit of measurement of Partial: Qts=Quarts Pts=Pints L=Litres Gal=Gallons |
| 5 | Indication of total multiplication factor (x10 / x100) | | |

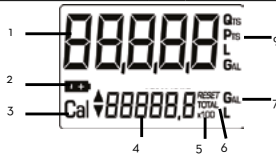

Measurement Chamber

The measuring chamber is located in the lower part of the instrument. It is fitted with connections for the installation of threaded flanges at inlet and outlet. The cover on the bottom part provides access to the measurement mechanism for any cleaning operations.

Inside the measuring chamber are the oval gears which, on turning, generate electrical pulses which are processed by the microprocessor-controlled electronic board.

By applying a suitable calibration factor (meaning a “weight” associated with each pulse), the microprocessor - on-board on meter versions and remote on pulser versions - translates the pulses generated by the fluid volume rotation expressed in the set units of measurement, displayed on the partial and total registers of the LCD.

Battery housing

All K600/2/3 meters are factory set with a calibration factor called FACTORY K FACTOR which is set according to the used fluid (diesel fuel or oil of SAE10 W40 type), for optimal measurement performance.

Calibration settings can be changed following the instructions in this manual, but you can return to the factory calibration at any time.

The METER is powered by two standard type 1.5 V batteries (size N).

The battery housing is closed by a threaded watertight cap that can be easily removed for quick battery change.

4.2 VERSION PULSER

The PULSER version is a pulse emitter (reed bulb) which translates the magnetic field variations generated by gear rotation into electric pulses to be sent to an external receiver. The receiver is to be connected according to the enclosed diagram. The pulser does not need any independent electric power supply, as it is directly powered by the receiver connection.

The issued pulse type is represented by a square wave generated by the voltage variation - see the following diagram:

The device calibration is carried out by means of the external pulse receiver.

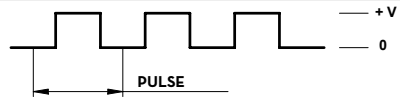

4.3 USERS BUTTONS

FOREWORD

The METER features two buttons (RESET and CAL) which individually perform two main functions and, together, other secondary functions.

MAIN FUNCTIONS PERFORMED SECONDARY FUNCTIONS LEGEND

- for the RESET key, resetting the partial register and Reset Total
- for the CAL key, entering instrument calibration mode

Used together, the two keys permit entering configuration mode where the desired unit of measurement can be set.

CALIBRATE MEANS PERFORMING ACTIONS ON THE METER KEYS. BELOW IS THE LEGEND OF THE SYMBOLS USED TO DESCRIBE THE ACTIONS TO BE PERFORMED

| | | | |
|---|--|---|--|
| <p>Short pressure of cal</p>  | <p>Long pressure of cal</p>  | <p>Short pressure of reset key</p>  | <p>Long pressure of reset key</p>  |
|---|--|---|--|

5 INSTALLATION

Avant-propos

K600 METER or PULSER features a 1 inch or 3/4inch inlet and outlet, depending on the fluid for which they were calibrated, threaded and perpendicular. It is designed for fixed in-line installation.

ATTENTION



Make sure the threaded connections do not interfere with the inside of the measuring chamber causing the gears to seize.

Do not use any conical connections which may damage the meter body or the connection flange.

Only the Pulser version must be connected by means of 2 cables according to the electrical features in the diagram:

Carry out installation by placing the suction filter.

To increase the life expectancy of the liter meters it is recommended to maintain a current value as low as possible (about 0.1 mA)

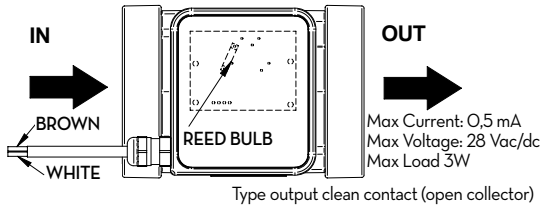

6 DAILY USE

FOREWORD

The only operations that need to be done for daily use are partial and/or resettable total register resetting. The user should use only the dispensing system of K600. Occasionally the meter may need to be configured or calibrated. To do so, please refer to the relevant chapters.

PULSER VER-SION

The pulser version of K600/3 meter when properly connected to the pulse receiver, does not need any start/stop operation.

Below are the two typical normal operation displays. One display page shows the partial and reset total registers. The other shows the partial and general total. Switchover from resettable total to general total display is automatic and tied to phases and times that are in factory set and cannot be changed.

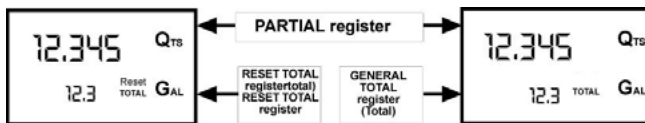

The Partial register

Positioned in the top part of the display indicates the quantity dispensed since the RESET key was last pressed

The RESET Total register

Positioned in the lower part of the display, indicates the quantity dispensed since the last RESET Total resetting. The RESET Total cannot be reset until the Partial has been reset, while vice versa, the Partial can always be reset without resetting the RESET Total. The unit of measurement of the two Totals can be the same as the Partial or else different according to the factory or user settings.

The General TOTAL register (Total)

Can never be reset by the user. It continues to rise for the entire operating life of the meter.

The register of the two totals (Reset Total and Total) The General Total (Total) The Reset Total is shown:

Share the same area and digits of the display. For this reason, the two totals will never be visible at the same time, but will always be displayed alternately.

Is shown during Meter standby

- At the end of a Partial reset for a certain time (a few seconds)
 - During the entire dispensing stage
 - For a few seconds after the end of dispensing. Once this short time has expired. Meter switches to standby and lower register display switches to General Total
- 6 digits are available for Totals, plus two icons x 10 / x100. The increment sequence is the following:**
0.0 -> 99999.9 -> 999999 -> 100000 x 10 -> 999999 x 10 -> 100000 x 100 -> 999999 x 100

NOTE



6.1 DISPENSING IN NORMAL MODE

FOREWORD

Normal mode is the standard dispensing. While the count is made, the partial and resettable total are displayed at the same time (reset total).

WARNING



Should one of the keys be accidentally pressed during dispensing, this will have no effect.

STAND BY

A few seconds after dispensing has ended, on the lower register, the display switches from resettable total to general total: the word reset above the word total disappears, and the reset total is replaced by the general total. This situation is called standby and remains stable until the user operates the K600 again.

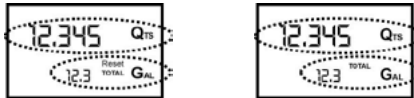

6.1.1 PARTIAL RESET (NORMAL MODE)

The partial register can be reset by pressing the reset key when the meter is in standby, meaning when the display screen shows the word "TOTAL".

After pressing the reset key, during reset, the display screen first of all shows all the lit-up digits and then all the digits that are not lit up.

At the end of the process, a display page is first of all shown with the reset partial and the reset total

and, after a few moments, the reset total is replaced by the non resettable Total.

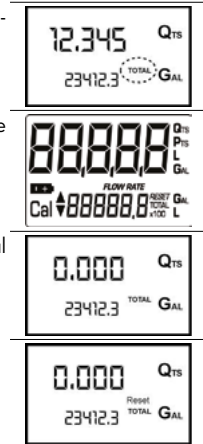

6.1.2 RESETTING THE RESET TOTAL

The reset total resetting operation can only be performed after resetting the partial register. The reset total can in fact be reset by pressing the reset key at length while the display screen shows reset total as on the following display page:

Schematically, the steps to be taken are:

- 1 Wait for the display to show normal standby display page (with total only displayed)
- 2 Press the reset key quickly
- 3 The meter starts to reset the partial
- 4 While the display page showing the reset total is displayed

Press the reset key again for at least 1 second

- 5 The display screen again shows all the segments of the display followed by all the switched-off segments and finally shows the display page where the reset Reset Total is shown.

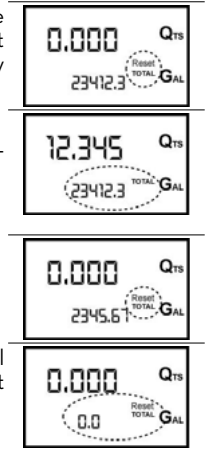

6.2 DISPENSING IN FLOW RATE MODE

FOREWORD

It is possible to dispense, displaying at the same time:

- the dispensed partial
- the Flow Rate in [Partial Unit / minute] as shown on the following display page:



Procedure for entering this mode:

- wait for the meter to go to Standby, meaning the display screen shows Total only
- quickly press the CAL key.
- Start dispensing

The flow rate is updated every 0.7 seconds. Consequently, the display could be relatively unstable at lower flow rates. The higher the flow rate, the more stable the displayed value.

ATTENTION



The flow rate is measured with reference to the unit of measurement of the Partial. For this reason, in case of the unit of measurement of the Partial and Total being different, as in the example shown below, it should be remembered that the indicated flow rate relates to the unit of measurement of the partial. In the example shown, the flow rate is expressed in Qts/min.

The word "Gal" remaining alongside the flow rate refers to the register of the Totals (Reset or NON Reset) which are again displayed when exiting from the flow rate reading mode.

To return to "Normal" mode, press the CAL key again. If one of the two keys RESET or CAL is accidentally pressed during the count, this will have no effect..

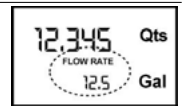

ATTENTION



Even though in this mode they are not displayed, both the Reset Total and the General Total (Total) increase. Their value can be checked after dispensing has terminated, returning to "Normal" mode, by quickly pressing CAL.

6.2.1 PARTIAL RESET

To reset the Partial Register, finish dispensing and wait for the meter to show a Flow Rate of 0.0 as indicated in the illustration

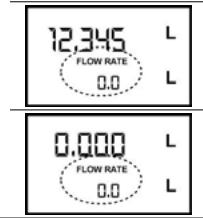

then quickly press RESET

NOTE



Unlike Normal mode, in this case during reset, you do not pass through the stages where the display segments are first lit up and then switched off, but rather the reset partial register is immediately displayed

7 CALIBRATION

7.1 DEFINITIONS

Calibration factor or “K Factor” This is the multiplication factor applied by the system to the electrical pulses received, to transform these into measured fluid units

Factory K Factor Factory-set default factor. It is equal to 1,000.

This calibration factor ensures utmost precision in the following operating conditions:

| | | |
|--------------------------------|----------------------|--------------------------|
| Version for diesel fuel | Fluid | Diesel |
| | Temperature : | 38°C |
| | Flow rate : | 10-100 litres/min |

| | | |
|------------------------|----------------------|--------------------------------|
| Version for oil | Fluid | motor oil type SAE10W40 |
| | Temperature : | 20°C |
| | Flow rate : | 6-60 litres/min |

USER K FACTOR Customized calibration factor, meaning modified by calibration.

Even after any changes have been made by the user, the factory K factor can be restored by means of a simple procedure.

7.2 CALIBRATION MODE

Why calibrate K600 METER is supplied with a factory calibration that ensures precise measuring in most operating conditions.

Nevertheless, when operating close to extreme conditions, such as for instance:

- with fluids close to acceptable range extremes (such as low-viscosity antifreeze or high-viscosity oils for gearboxes)
- in extreme flow rate conditions (close to minimum or maximum acceptable values) on-the-spot calibration may be required to suit the real conditions in which the meter is required to operate.

When operating close to extreme use or flow rate conditions (close to minimum or maximum acceptable values), an on-the-spot calibration may be required to suit the real conditions in which the K600 is required to operate.

FOREWORD K600 METER permits making quick and precise electronic calibration by changing the Calibration Factor (K FACTOR).

Two procedures are available for changing the Calibration Factor:

- 1 In-Field Calibration, performed by means of a dispensing operation
- 2 Direct Calibration, performed by directly changing the calibration factor

The calibration phases can be entered (by keeping the CAL key pressed for a long time) to :

- Display the currently used calibration factor

- Return to factory calibration (Factory K Factor) after a previous calibration by the user
- Change the calibration factor using one of the two previously indicated procedures.
 - 1- In calibration mode, the partial and total dispensed quantities indicated on the display screen take on different meanings according to the calibration procedure phase.
 - 2- In calibration mode, the METER cannot be used for normal dispensing operations.
 - 3- In "Calibration" mode, the totals are not increased.

ATTENTION



The METER features a non-volatile memory that keeps the data concerning calibration and total dispensed quantity stored for an indefinite time, even in the case of a long power break; after changing the batteries, calibration need not be repeated.

7.2.1 DISPLAY OF CURRENT CALIBRATION FACTOR AND RESTORING FACTORY FACTOR.



By pressing the CAL key while the appliance is in Standby, the display page appears showing the current calibration factor used. If no calibration has ever been performed, or the factory setting has been restored after previous calibrations, the following display page will appear:



The word "Fact" abbreviation for "factory" shows that the factory calibration factor is being used

If, on the other hand, calibrations have been made by the user, the display page will appear showing the currently used calibration factor (in our example 0,998) . The word "user" indicates a calibration factor set by the user is being used..



The flow chart alongside shows the switchover logic from one display page to another

In this condition, the Reset key permits switching from User factor to Factory factor.

To confirm the choice of calibration factor, quickly press CAL while "User" or "Fact" are displayed.

After the restart cycle, the meter uses the calibration factor that has just been confirmed

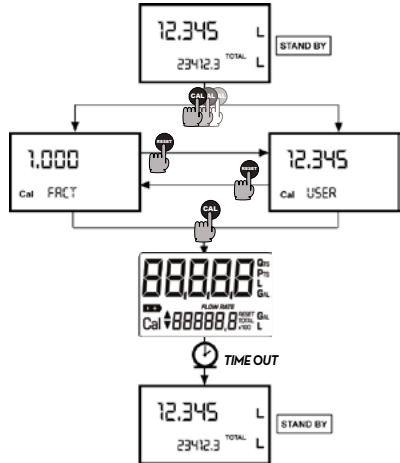

ATTENTION

When the Factory Factor is confirmed, the old User factor is deleted from the memory











7.2.2 IN FIELD CALIBRATION

FOREWORD This procedure calls for the fluid to be dispensed into a graduated sample container in real operating conditions (flow rate, viscosity, etc.) requiring maximum precision.



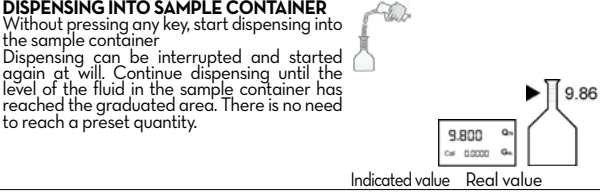

ATTENTION  **For correct K600 calibration, it is most important to:**

- 1 When the Factory Factor is confirmed, the old User factor is deleted from the memory
- 2 Use a precise Sample Container with a capacity of not less than 5 litres, featuring an accurate graduated indicator.
- 3 Ensure calibration dispensing is done at a constant flow rate equivalent to that of normal use, until the container is full;
- 4 Not reduce the flow rate to reach the graduated area of the container during the final dispensing stage (the correct method during the final stages of sample container filling consists in making short top-ups at normal operation flow rate);
- 5 After dispensing, wait a few minutes to make sure any air bubbles are eliminated from the sample container; only read the Real value at the end of this stage, during which the level in the container could drop.
- 6 Carefully follow the procedure indicated below.

7.2.2.1 IN-FIELD CALIBRATION PROCEDURE

| ACTION | | DISPLAY |
|--------|--|--|
| 1 | NONE Meter in Standby |  |
| 2 |  LONG CAL key keying The Meter enters calibration mode, shows <<CAL>> and displays the calibration factor in use instead of partial. The words "Fact" and "USER" indicate which of the two factors (factory or user) is currently in use. Important: This factor is that which the instrument also uses for field calibration measurement operations |  |
| 3 |  LONG RESET key keying The Meter shows "CAL" and the partial at zero. The Meter is ready to perform in-field calibration. |  |
| 4 | DISPENSING INTO SAMPLE CONTAINER Without pressing any key, start dispensing into the sample container Dispensing can be interrupted and started again at will. Continue dispensing until the level of the fluid in the sample container has reached the graduated area. There is no need to reach a preset quantity. |  |
| 5 |  SHORT RESET key keying The Meter is informed that the calibration dispensing operation is finished. Make sure dispensing is correctly finished before performing this operation. To calibrate the Meter, the value indicated by the partial totaliser (example 9,800) must be forced to the real value marked on the graduated sample container. In the bottom left part of the display an arrow appears (upwards and downwards) that shows the direction (increase or decrease) of the value change displayed when the following operations 6 or 7 are performed. |  |
| 6 |  SHORT RESET key keying The arrow changes direction. The operation can be repeated to alternate the direction of the arrow. |  |

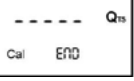
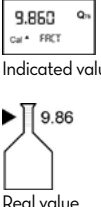
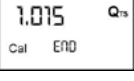

| | | |
|--|---|---|
| <p>7</p>  | <p>SHORT/LONG CAL key keying The indicated value changes in the direction indicated by the arrow - one unit for every short CAL key keying - continually if the CAL key is kept pressed. The speed increase rises by keeping the key pressed. If the desired value is exceeded, repeat the operations from point (6).</p> |  |
| <p>8</p>  | <p>LONG RESET key keying The Meter is informed that the calibration procedure is finished. Before performing this operation, make sure the INDICATED value is the same as the REAL value. The Meter calculates the new USER K FACTOR ; this calculation could require a few seconds, depending on the correction to be made ATTENTION: If this operation is performed after action (5), without changing the indicated value, the USER K FACTOR would be the same as the FACTORY K FACTOR, thus it is ignored.</p> |   |
| <p>9</p> | <p>NO OPERATION At the end of the calculation, the new USER K FACTOR is shown for a few seconds, after which the restart cycle is repeated to finally achieve standby condition. IMPORTANT: From now on, the indicated factor will become the calibration factor used by the Meter and will continue to remain such even after a battery change</p> |  |
| <p>10</p> | <p>NO OPERATION The Meter stores the new work calibration factor and is ready to begin dispensing, using the USER K FACTOR that has just been calculated..</p> |  |

7.2.3 DIRECT MODIFICATION OF K FACTOR

If normal Meter operation shows a mean percentage error, this can be corrected by applying to the currently used calibration factor a correction of the same percentage. In this case, the percentage correction of the USER K FACTOR must be calculated by the operator in the following way

$$\text{New cal. Factor} = \text{Old Cal Factor} * \left(\frac{100 - E\%}{100} \right)$$





EXAMPLE





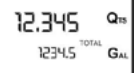

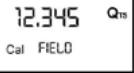

Error percentage found: E% - 0.9 %

CURRENT calibration factor: 1.000

New USER K FACTOR: $1.000 * [(100 - (- 0.9))/100] = 1.000 * [(100 + 0.9)/100] = 1.009$

If the Meter indicates less than the real dispensed value (negative error) the new calibration factor must be higher than the old one as shown in the example. The opposite applies if the Meter shows more than the real dispensed value (positive error).

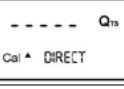
| ACTION | | DISPLAY |
|--|---|--|
| <p>1</p> | <p>NONE METER in Standby.</p> |  |
| <p>2</p>  | <p>LONG CAL KEY KEYING Meter enters calibration mode, shows "CAL" and displays the calibration factor being used instead of the partial. The words "Fact" and "User" indicate which of the two factors (factory or user) is currently being used.</p> |  |
| <p>3</p>  | <p>LONG RESET KEY KEYING The Meter shows "CAL" and the zero partial total. Meter is ready to perform in-field calibration by dispensing - see previous paragraph.</p> |  |

| | | |
|--|---|---|
|  <p>4</p> | <p>LONG RESET KEY KEYING We now go on to Direct change of the calibration factor: the word "Direct" appears together with the Currently Used calibration factor. In the bottom left part of the display, an arrow appears (upwards or downwards) defining the direction (increase or decrease) of change of the displayed value when subsequent operations 5 or 6 are performed.</p> |  |
|  <p>5</p> | <p>SHORT RESET KEY KEYING Changes the direction of the arrow. The operation can be repeated to alternate the direction of the arrow.</p> |  |
|  <p>6</p> | <p>SHORT/LONG CAL KEY KEYING The indicated value changes in the direction indicated by the arrow - one unit for every short CAL key keying - continually if the CAL key is kept pressed. The speed increase rises by keeping the key pressed. If the desired value is exceeded, repeat the operations from point (5).</p> |  |
|  <p>7</p> | <p>LONG RESET KEY KEYING The Meter is informed that the calibration procedure is finished. Before performing this operation, make sure the INDICATED value is that required.</p> |  |
| <p>8</p> | <p>NO OPERATION At the end of the calculation, the new USER K FACTOR is shown for a few seconds, after which the restart cycle is repeated to finally achieve standby condition. IMPORTANT: From now on, the indicated factor will become the calibration factor used by the Meter and will continue to remain such even after a battery change</p> |  |
| <p>9</p> | <p>NO OPERATION The Meter stores the new work calibration factor and is ready to begin dispensing, using the USER K FACTOR that has just been changed.</p> |  |





8 METER CONFIGURATION

The METER feature a menu with which the user can select the main measurement unit, Quarts (Qts), Pints (Pts), Litres (Lit), Gallons (Gal). The combination of the unit of measurement of the Partial register and that of the Totals is predefined according to the following table:

| Combination no. | Unit of Measurement Partial Register | Unit of Measurement Totals Register |
|-----------------|--------------------------------------|-------------------------------------|
| 1 | Litres (L) | Litres (L) |
| 2 | Gallons (Gal) | Gallons (Gal) |
| 3 | Quarts (Qts) | Gallons (Gal) |
| 4 | Pints (Pts) | Gallons (Gal) |

To choose between the 4 available combinations:

- 

Wait for the METER to go to Standby
Then press the CAL and RESET keys together. Keep these pressed until the word "UNIT" appears on the screen together with the unit of measurement set at that time (in this example Litres / Litres)
- 

Every short press of the RESET key, the various combinations of the units of measurements are scrolled as shown below:
- 

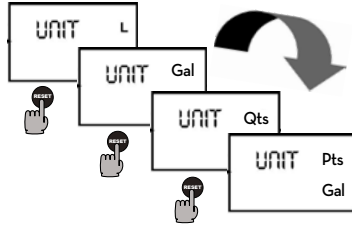

By pressing the CAL key at length, the new settings will be stored, the METER will pass through the start cycle and will then be ready to dispense in the set units.



The Reset Total and Total registers will be automatically changed to the new unit of measurement. NO new calibration is required after changing the Unit of Measurement.

9 MAINTENANCE

9.1 CHANGE BATTERY

FOREWORD

The METER has been designed to require a minimum amount of maintenance. The only maintenance jobs required are:

- Battery change - necessary when the batteries have run down
- Cleaning the measurement chamber. This may be necessary due to the particular nature of the dispensed fluids or due to the presence of solid particles following bad filtering

BATTERY REPLACEMENT WARNING



K600 should be installed in a position allowing the batteries to be replaced without removing it from the system.

K600 features two low-battery alarm levels:

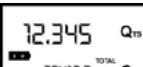
1  When the battery charge falls below the first level on the LCD, the fixed battery symbol appears. In this condition, K600 continues to operate correctly, but the fixed icon warns the user that it is ADVISABLE to change the batteries.

2  If K600 operation continues without changing the batteries, the second battery alarm level will be reached which will prevent operation. In this condition the battery icon starts to flash and is the only one to remain visible on the LCD.

To change the batteries, with reference to the exploded diagram positions, proceed as follows

- 1 Press RESET to update all the totals
- 2 Unscrew the battery cap (pos.8)
- 3 Remove the old batteries
- 4 Place the new batteries in the same position as the old ones, making sure the positive pole is positioned as indicated on the cover (pos. 9). Re-tighten the battery cap, making sure the seal (pos.1) are correctly positioned.
- 5 The METER will switch on automatically and normal operation can be resumed.

The METER will display the same Reset Total, the same Total and the same Partial indicated before the batteries were changed. After changing the batteries, the meter does not need calibrating again.

ATTENTION



Do not discard the old batteries in the environment. Refer to local disposal regulations.

9.2 CLEANING

CLEANING THE MEASURING CHAMBER

ATTENZIONE



The K600 measuring chamber can be cleaned without removing the instrument from the line on which it is fitted. Make sure the gears are turning freely before closing the cover.

Always make sure that the liquid has drained from the meter before cleaning.

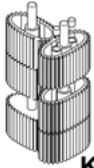

K600/3

To clean the chamber, proceed as follows (with reference to the exploded diagram positions):

- 1 Loosen the four retention screws of the lower cover (pos. 7).
- 2 Remove the cover (pos. 7) and the seal (pos. 6).
- 3 Remove the oval gears.
- 4 Clean where necessary. For this operation, use a brush or pointed object such as a small screwdriver.
Be careful not to damage the body or the gears.
- 5 To reassemble the instrument, perform the operations in the opposite sequence.

ATTENTION



Perform the assembly diagram to reassemble the gears.

Only one of the two gears, modularly coupled as shown in the picture aside, features magnets. Observe the position of the gear with magnets, as shown in the figure. Fit the second gear (without magnets) with axis greater than 90° compared to the first gear.

CLEANING THE FILTER

ATTENTION



Always make sure that the liquid has drained from the meter before cleaning.

To clean the filter, proceed as follows (with reference to the exploded diagram positions):

- 1 To access the filtering disk of the K600/3, loosen the 2 fixing screws of the connection flange at the inlet. Remove both flanges if it is necessary for the system.
- 2 Remove the meter from the line, being careful to remove also the gaskets between the flanges and threaded connections of K600.
- 3 Slide out the filter (pos. 9)
- 4 Clean the filter with compressed air.
- 5 Carry out the reverse procedure to reassemble the filter.

10 MALFUNCTIONS

| PROBLEM | POSSIBLE CAUSE | REMEDIAL ACTION |
|---|--|--|
| ELECTRONIC MALFUNCTIONS | | |
| LCD: no indications | Bad battery contact | Check battery contacts |
| Not enough measurement precision | Wrong K FACTOR | With reference to paragraph H, check the K FACTOR |
| | The meter works below minimum acceptable flow rate | Increase the flow rate until an acceptable flow rate range has been achieved |
| The meter does not count, but the flow rate is correct | Incorrect installation meters after cleaning | Repeat the reassembly procedure |
| | Possible electronic board problems | Contact your dealer |
| MECHANICAL MALFUNCTIONS | | |
| Reduced or zero flow rate | Gears blocked | Clean the measuring chamber |
| The meter does not count, but the flow rate is correct | Incorrect installation of gears after cleaning | Repeat the reassembly procedure |
| Inaccuracy | Incorrect calibration of pulser version | Calibrate the device with the pulse receiver |
| | Working flow-rate outside the flow-rate range | Reduce or increase the flow-rate to return to the indicated flow-rate range. |
| High loss of head | Dirty filter | Clean the filter |
| | Braked gears | Clean the measuring chamber |
| It does not count | Wrong gear installation | Check the position of the gear with magnet. |
| | Faulty bulb | Change the bulb |

11 DEMOLITION AND DISPOSAL

Foreword

If the system needs to be disposed, the parts which make it up must be delivered to companies that specialize in the recycling and disposal of industrial waste and, in particular:

Disposing of packing materials

The packaging consists of biodegradable cardboard which can be delivered to companies for normal recycling of cellulose.

Metal parts disposal

Metal parts, whether paint-finished or in stainless steel, can be consigned to scrap metal collectors.

Disposal of electric and electronic components

These must be disposed of by companies that specialize in the disposal of electronic components, in accordance with the indications of directive 2012/19/EU (see text of directive below).



European Directive 2012/19/EU requires that all equipment marked with this symbol on the product and/or packaging not be disposed of together with non-differentiated urban waste. The symbol indicates that this product must not be disposed of together with normal household waste. It is the responsibility of the owner to dispose of these products as well as other electric or electronic equipment by means of the specific refuse collection structures indicated by the government or the local governing authorities.

Disposing of RAEE equipment as household wastes is strictly forbidden. Such wastes must be disposed of separately.

Information regarding the environment for clients residing within the european union

Any hazardous substances in the electrical and electronic appliances and/or the misuse of such appliances can have potentially serious consequences for the environment and human health.

In case of the unlawful disposal of said wastes, fines will be applicable as defined by the laws in force.

Miscellaneous parts disposal

Other components, such as pipes, rubber gaskets, plastic parts and wires, must be disposed of by companies specialising in the disposal of industrial waste.

12 TECHNICAL SPECIFICATIONS

| | | K600/3 (oil) | | K600/3 (diesel fuel) | |
|---|--------------------|----------------------------|--------|-----------------------------|--------|
| | | Meter | Pulser | Meter | Pulser |
| Resolution | Pulse / l | 35 | 35 | 33,5 | 33,5 |
| | Pulse / Gal | 132,5 | 132,5 | 127 | 127 |
| Flow-rate range | L/min | 6 · 60 | | 10 · 100 | |
| Operating pressure | bar | 70 | | 30 | |
| Bursting pressure | bar | 140 | | 60 | |
| Measurement system | | Elliptical gears | | | |
| Storage temperature | °C | -20 · +70 | | | |
| Degree of impermeability | | IP65 | | | |
| Storage humidity | H.R. | 95% | | | |
| Operating temperature (Max) | °C | -10 · +60 | | | |
| Loss of Head at maximum flow rate | bars | 0.3 (SAE 10W/40 @ 20°C) | | 0.3 (diesel fuel @ 20°C) | |
| Compatible Fluids | | oil | | diesel fuel | |
| Viscosity Range | cSt | 10 · 2000 | | 2 · 5,35 | |
| Accuracy (within capacity range) | | 0,5 | | | |
| Repeatability | | 0,2% | | | |
| Weight | Kg | 1,6 | | 1,6 | |
| Input and Output Connection Thread | | 3/4" Gaz | | 1" Gaz | |
| Batteries | | 2 x 1.5 Volt | | 2 x 1.5 Volt | |
| Battery Life (expected) | | 18-36 months | | 18-36 months | |

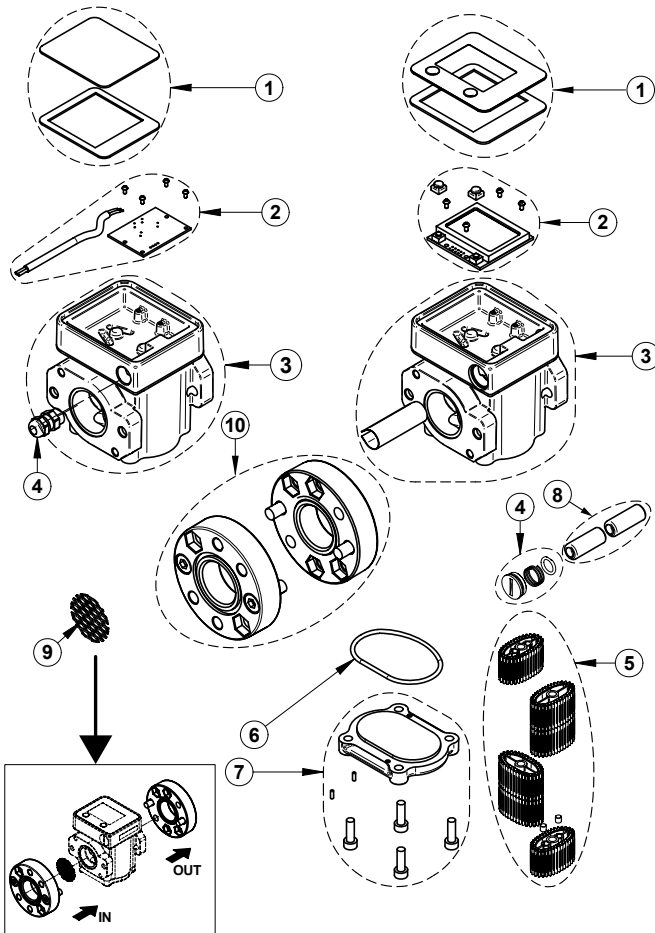
13 EXPLODED VIEW / DIMENSIONS**K600 PULSER****K600 METER**

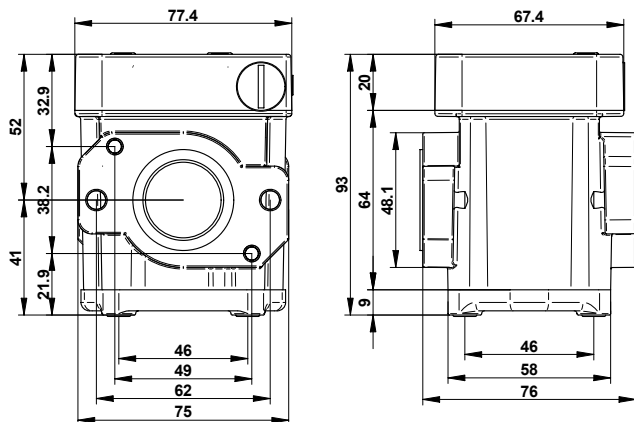

EN





- IT Scarica il manuale nella tua lingua!
- EN Download the manual in your language!
- CS Stáhnout příručku ve vašem jazyce!
- DA Download manualen på dit sprog!
- DE Laden Sie das Handbuch in Ihrer Sprache herunter!
- ES ¡Descarga el manual en tu idioma!
- FI Lataa käsikirja omalla kielelläsi!
- FR Téléchargez le manuel dans votre langue!
- NL Download de handleiding in uw taal!
- PL Pobierz instrukcję w swoim języku!
- PT Baixe o manual em seu idioma!
- RU Загрузите руководство на вашем языке



[https://www.piusi.com/
support/search-manuals](https://www.piusi.com/support/search-manuals)

piusi.com
PIUSI SpA • Suzzara MN Italy