

mato

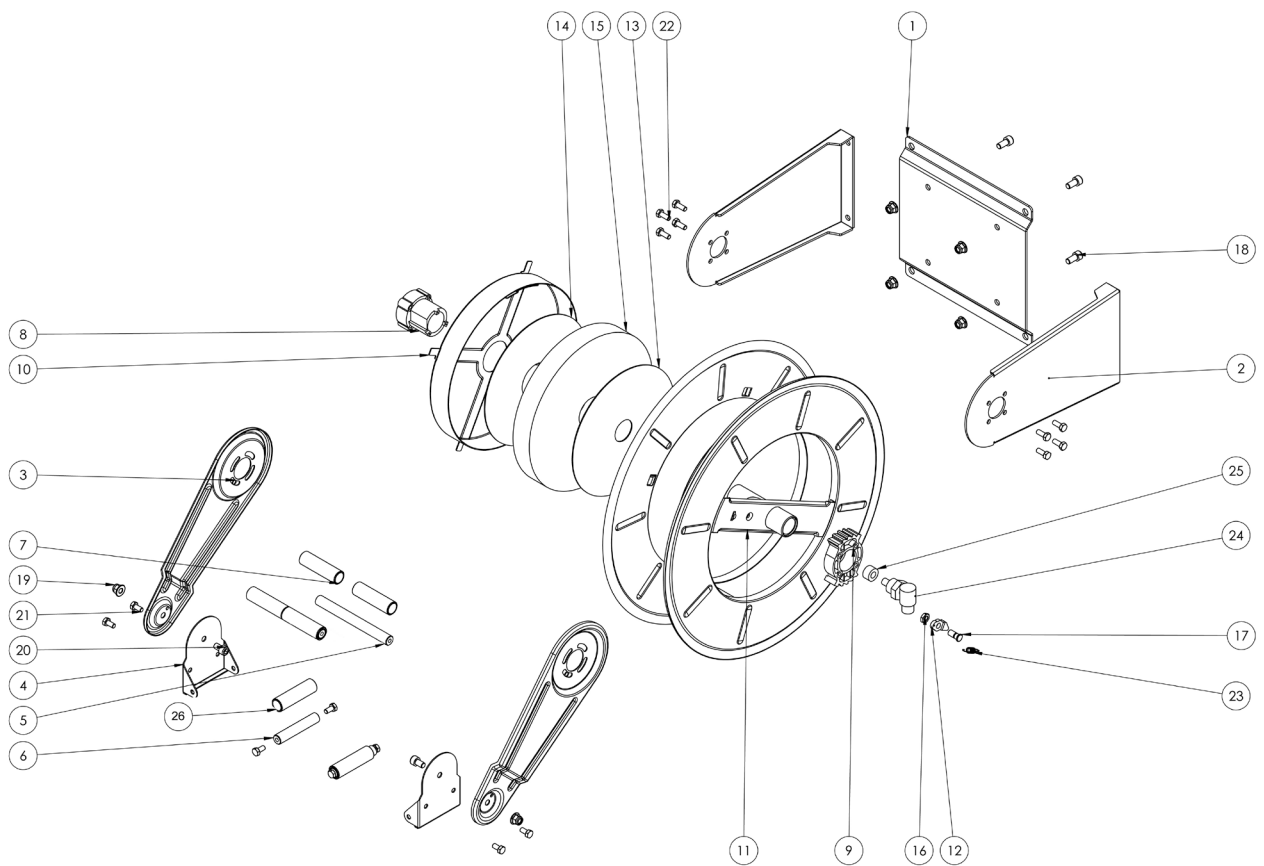

20 219 01

EXPLODED VIEW › ESPLOSO





mato



20 219 01

EXPLODED VIEW › ESPLOSO

POS	Description and quantity / Descrizione e quantità	20 219 01	
1	Base (1x)		
2	Side fixed arm / Fiancata fissa (2x)		
3	Mobile arm / Fiancata mobile (2x)		
4	Roller guide / Guida rullino (2x)		
5	Horizontal rod / Tirante orizzontale (2x)		
6	Vertical rod / Tirante verticale (2x)		
7	Horizontal roller / Rullino orizzontale (2x)		
8	Plastic hub / Perno in plastica (1x)	KIT 94	
10	Spring case / Padellotto portamolla (1x)		
13	Plastic separator / Distanziale in plastica (1x)		
14	Plastic separator / Distanziale in plastica (1x)		
15	Main spring / Molla principale (1x)		
9	Plastic rack / Cremagliera in plastica (1x)	KIT CR 1	
11	Reel / Bobina (1x)		
12	Plastic ratchet / Salterello in plastica nudo (1x)	KIT 93	RC 10
17	Ratchet screw + (16) nut / Vite per salterello + (16) dado (1x)		RC 20
23	Ratchet spring / Molla per salterello (1x)		KIT 12
16	Nut / Dado (8x)		
18	Screw / Vite (4x)		
19	Nut / Dado (4x)		
20	Screw / Vite (2x)		
21	Nut / Dado (2x)		
22	Screw / Vite (8x)		
24	Swivel joint / Giunto girevole (1x)	4971	
25	Bushing seal / Boccola tenuta (1x)		KIT20 NEW
26	Vertical roller / Rullino verticale (2x)		